



Flex

Elementary shapes and substantial thickness create a bed that inspires comfort and well-being just by looking at it. Pinched seams create a slim border that enhances the geometric lines of the headboard. Headboard and bed frame in fabric, leather or eco-leather, matching or contrast pinched seam. Available in versions with or without storage base.

Elementary shapes and substantial thickness create a bed that inspires comfort and well-being just by looking at it. Pinched seams create a slim border that enhances the geometric lines of the headboard. Testiera e giroletto in tessuto, pelle o ecopelle, bordo perimetrale colore o a contrasto. Disponibile nelle versioni con o senza contenitore.

FINISHES

Moss fabric (Sahco)



0001



0002



0003



0004



0005



0006



0007



0008



0009

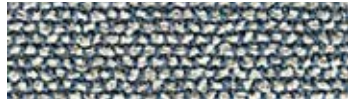

0010



0011

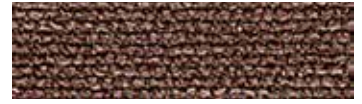

0012

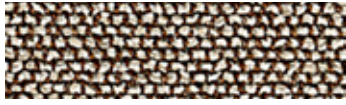

0013



0014



0015



0016



0017



0018



0019



0020

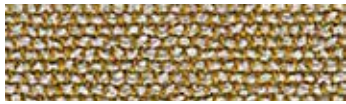

0021



0022

Design: Vincent Van Duysen
 Composition: 52% Cotton,
 22% Viscose, 14% Acrylic,
 6% Linen, 3% Polyester, 3% Nylon
 Weight: 920 g/lin.m
 Durability: 50.000 Martindale

Pilling: 4-5
 Lightfastness: 6-7
 Cleaning and care:



FINISHES

Divina Melange 3 fabric (Kvadrat)



Design: Finn Sködt
 Composition: 100% new wool
 Abrasion: app. 45.000 Martindale
 Cleaning and care:

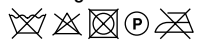

FINISHES

Valencia synthetic leather (Spradling)



Composition: Topcoat 100% vinyl,
backing 100% polyester Hi-Loft
Abrasion: app. 300.000 Martindale
Cleaning and care:



FINISHES

Neocoast leather (Elmo)



99076



91097



91100



71010



18008



12097



02061



00114



93090



98016



43041



43084



95042



55058



45024



44015



77022



77035



98043



88017

FINISHES

Narvik



111



400



401



402



403



600



602



601



405



200



706



801



511

Composition: 100% Polyester
Weight: 320 gr/mq – 9.4 oz/sqy
Abrasion: 30.000 rubs
Lightfastness: >4
Pilling: 4

Rubbing: dry 4–5, wet 4
Water repellent, stain removable
Cleaning and care:



Bruges



100



400



401



605



600



402



403



405



602



707



303



700



604

Composition: 100% Polyester
Weight: 330 gr/mq – 9.7 oz/sqy
Abrasion: 30.000 rubs
Lightfastness: 3–4
Pilling: 4–5

Rubbing: dry 4–5, wet 4–5
Water repellent
Cleaning and care:



FINISHES

Bilbao

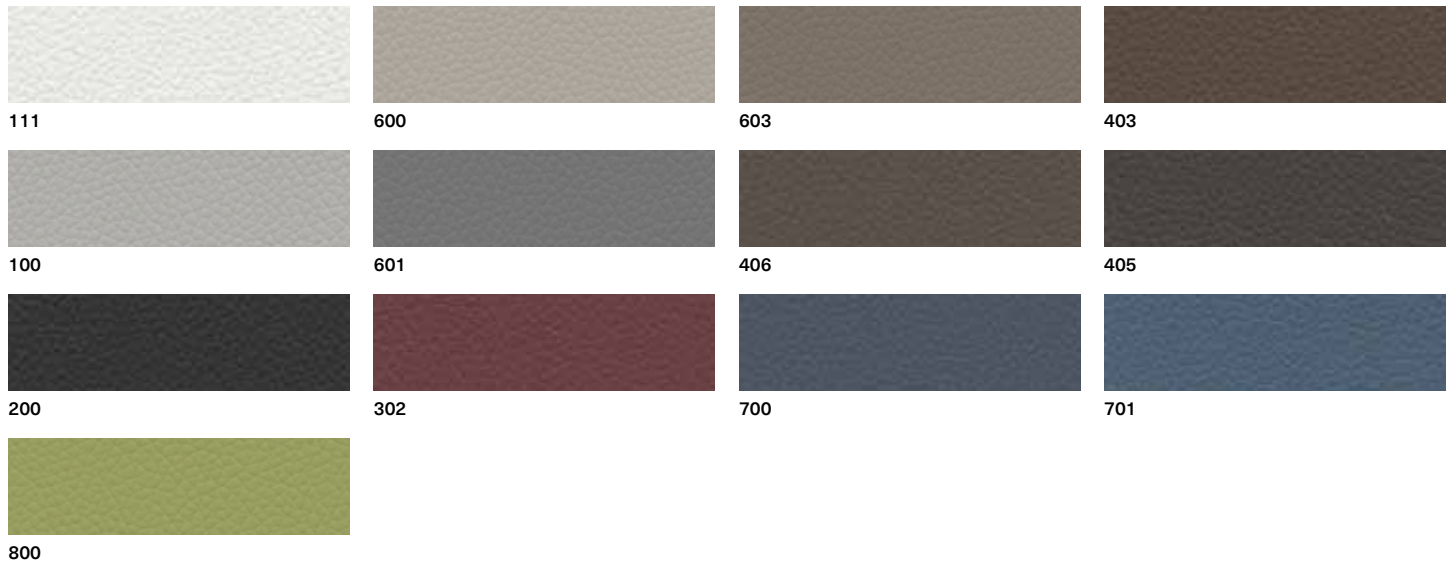

Composition: 90% PVC, 10% Polyester
 Weight: 490 gr/mq – 14.4 oz/sqy
 Abrasion: 50.000 rubs
 Rubbing: dry 5, wet 5

Fire retardant: EN 1021 1/2
 BS 5852 IS 0 cigarette
 BS 5852 IS 1 match
 California TB 117: 2013

Cleaning and care:



Glasgow

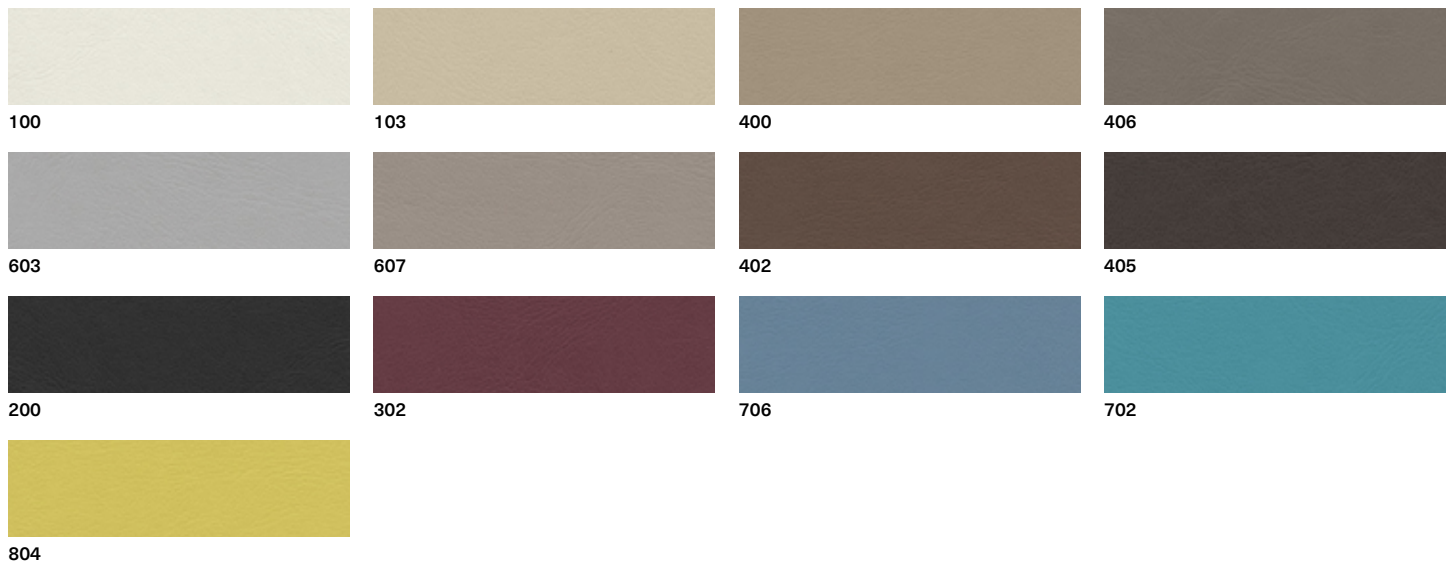

Composition: 88% PVC, 7% Polyester
 Weight: 715 gr/mq – 21 oz/sqy
 Abrasion: ≥200.000 rubs
 Lightfastness: ≥7
 Rubbing: dry ≥5, wet ≥5

Fire retardant:
 UNI 9175 Class 11M
 EN 1021-1/2 2006
 BS 5852 IS 0/1
 California TB 117: 2013

FTP Code 307(88)
 ex. IMO res. A 652 (16)
 NF P 503 Class M1
 DIN 4102 - 1 Class B1
 BS 5852 IS CRIB 5

Cleaning and care:



FINISHES

Cardiff

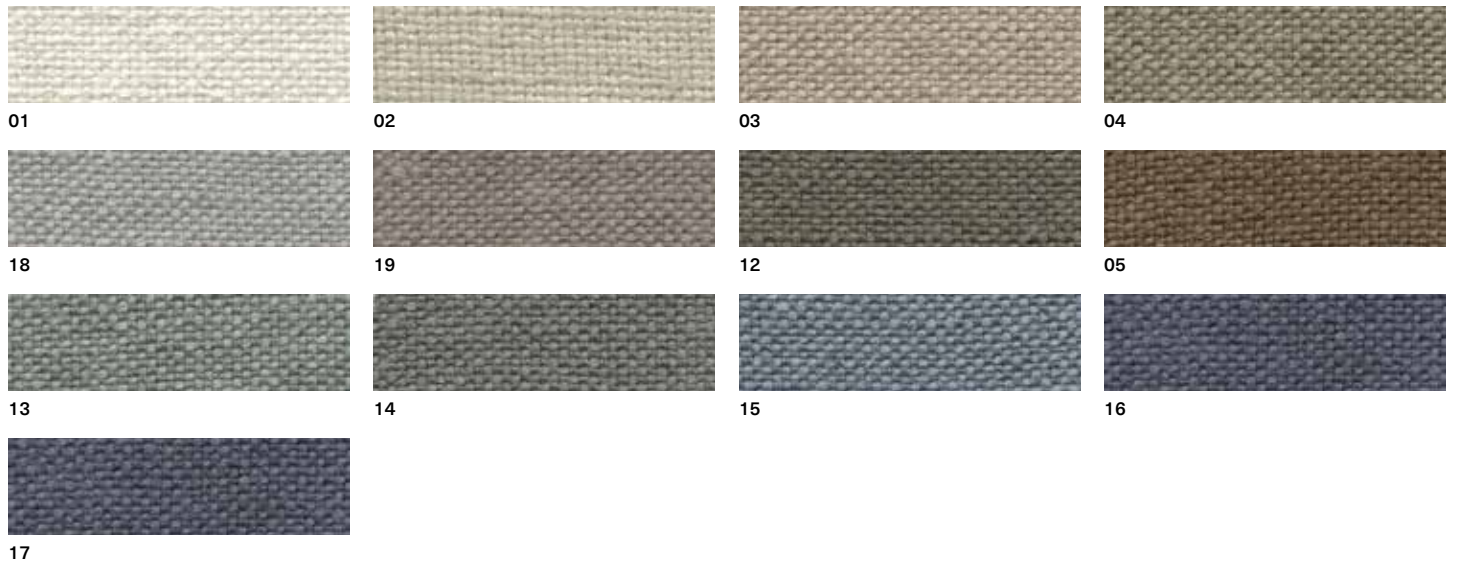

Composition: 54% jute, 46% Linen
 Weight: 670 gr/ml – 14 oz/sqy
 Abrasion: app. 22.000 rubs
 Lightfastness: 3–4
 Pilling: 3

Rubbing: dry >4 wet >3–4
 Cleaning and care:
 (P) (X) (W) (D)

Parigi

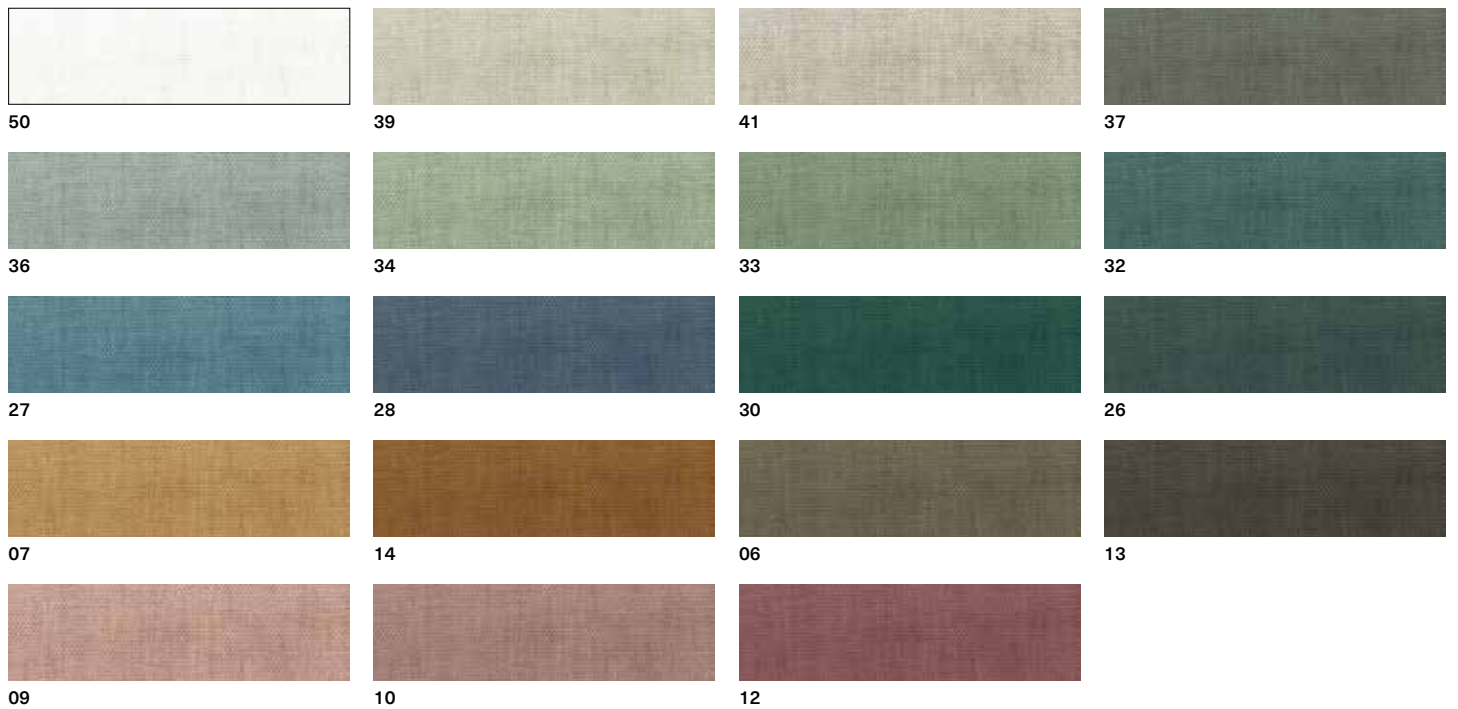

Composition: 100% Linen
 Weight: 680 gr/ml – 14.3 oz/sqy
 Abrasion: app. 30.000 rubs
 Lightfastness: 6
 Pilling: 3–4

Rubbing: dry >4/5 wet >3
 Fire resistance:
 BS 5852: 1979 part 0/1
 cigarette test: pass
 match test: none

Cleaning and care:
 (30) (P) (X) (W) (D)

FINISHES

Londra

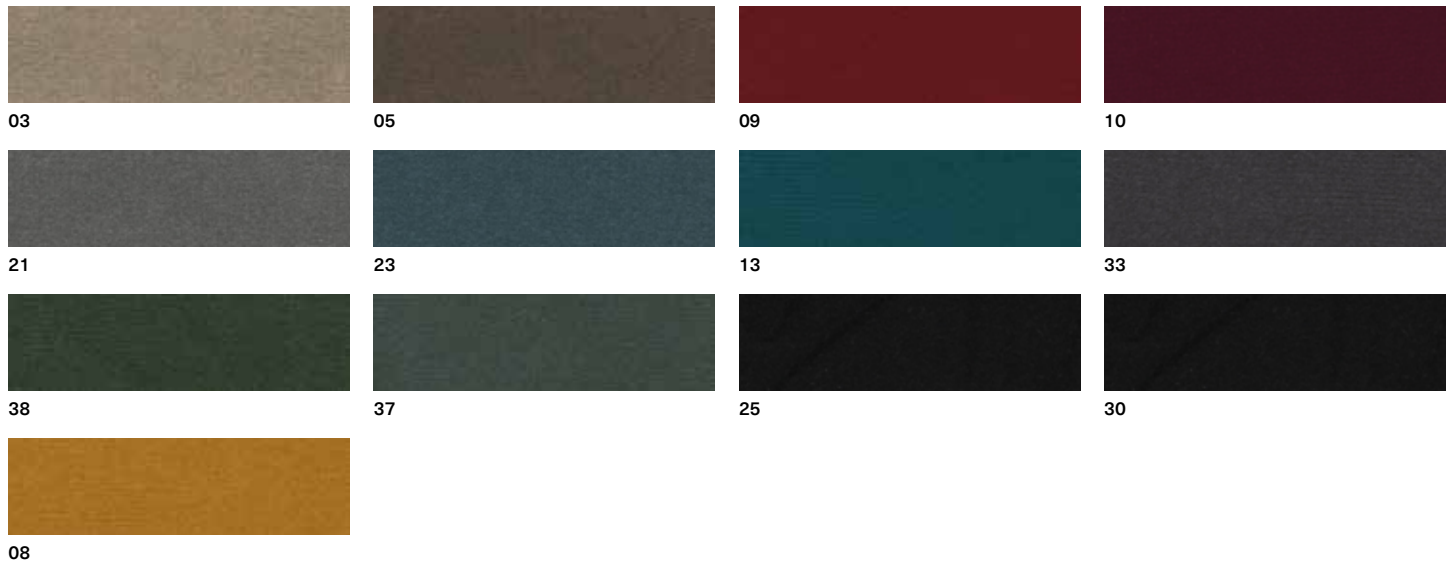

Composition: 100% Cotton
 Weight: 620 gr/ml – 13 oz/sqy
 Abrasion: 65.000 rubs
 Lightfastness: 6
 Pilling: 5

Rubbing: dry >5 wet >4/4
 Fire resistance:
 BS 5852: 1979 part 0/1
 cigarette test: pass
 match test: none

Cleaning and care:



Divina MD

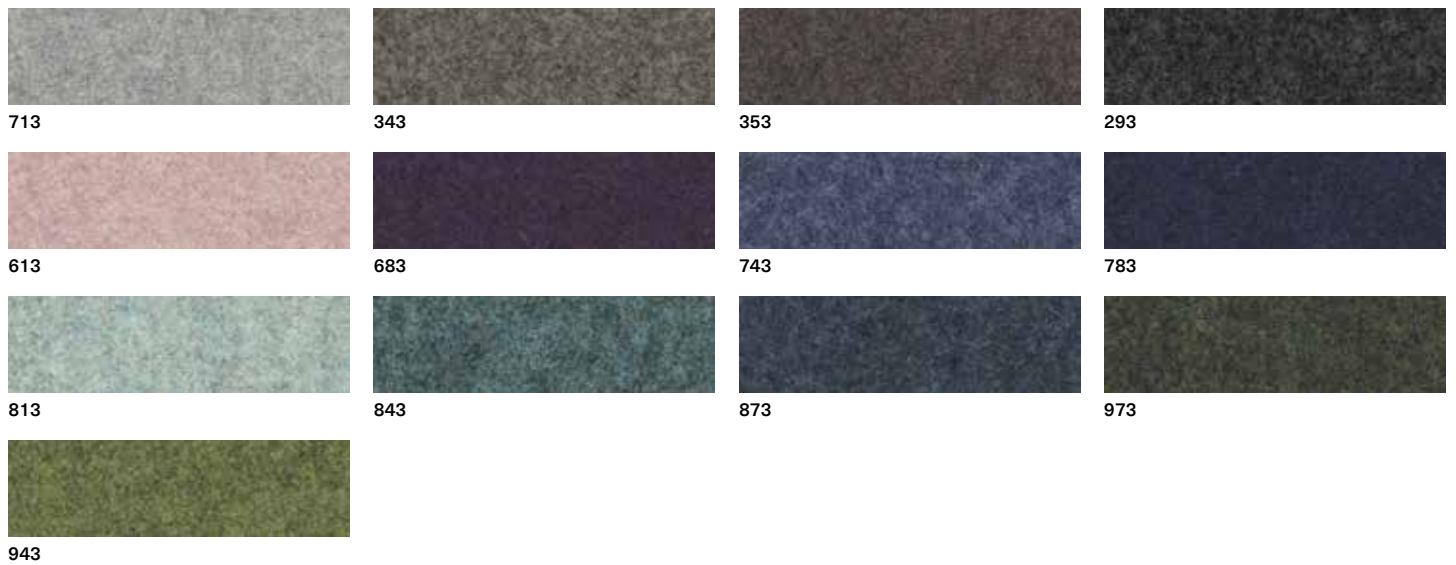

Composition: 100% New Wool
 Weight: 820 gr/mq - 17.2 oz/sqy
 Abrasion: 45.000 rubs
 Lightfastness: 5-7
 Pilling: 3

Fire resistance:
 AS/NZS 1530.3
 BS 5852 Crib 5 - part 1
 DIN 4102 B2
 EN 1021-1/2

IMO FTP Code 2010:Part 8
 NF D 60 013
 NFPA 260
 Önorm B1/Q1
 SN 198 898 5.3

UNI 9175 11M
 US Cal. Bull. 117-2013
 Cleaning and care:



FINISHES

Belfast



Composition: 100% Leather
Raw material: European bovine
Tannage: Chrome
Lightfastness: ≥4
Rubbing: dry ≥1.000, wet ≥50

Fire resistance: no ignition
ISO 1021/1 - 2
BS5852 part 1 source 0/1
IMO FTP8 Res. A652
California TB 117

UNI 9175 11M
US Cal. Bull. 117-2013
Cleaning and care: dust with
a soft and dry cloth, avoid cleaning
with aggressive products

Shades of colour cannot be
reproduced exactly on printed paper.
MD House Srl is entitled to make
modifications at any time and without
prior notice.

TECHNICAL DETAILS

Dimensions

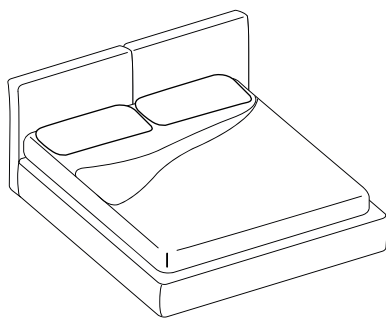

	Bed base	Internal dimesions	External dimensions
	140x200 55 1/8 x 78 9/8	142x202 55 7/8 x 79 4/8	L 174 H 95 P 232 W 68 4/8 H 37 3/8 D 91 3/8
	150x200 59 x 78 9/8	152x202 59 7/8 x 79 4/8	L 184 H 95 P 232 W 72 4/8 H 37 3/8 D 91 3/8
	160x200 63 x 78 9/8	162x202 63 5/8 x 79 4/8	L 194 H 95 P 232 W 76 3/8 H 37 3/8 D 91 3/8
	180x200 70 7/8 x 78 9/8	182x202 71 5/8 x 79 4/8	L 214 H 95 P 232 W 84 2/8 H 37 3/8 D 91 3/8
AU – USA QS	153x203 60 2/8 x 79 7/8	155x205 61 x 80 9/8	L 197 H 95 P 237 W 77 4/8 H 37 3/8 D 93 2/8
AU KS	183x203 72 x 79 7/8	185x205 72 7/8 x 80 9/8	L 217 H 95 P 237 W 85 3/8 H 37 3/8 D 93 2/8
USA KS	193x203 76 x 79 7/8	195x205 76 5/8 x 80 9/8	L 227 H 95 P 237 W 89 3/8 H 37 3/8 D 93 2/8

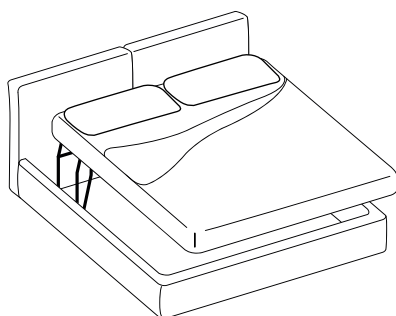

	Bed base + storage	Internal dimesions	External dimensions
	140x200 55 1/8 x 78 9/8	142x202 55 7/8 x 79 4/8	L 174 H 95 P 232 W 68 4/8 H 37 3/8 D 91 3/8
	150x200 59 x 78 9/8	152x202 59 7/8 x 79 4/8	L 184 H 95 P 232 W 72 4/8 H 37 3/8 D 91 3/8
	160x200 63 x 78 9/8	162x202 63 5/8 x 79 4/8	L 194 H 95 P 232 W 76 3/8 H 37 3/8 D 91 3/8
	180x200 70 7/8 x 78 9/8	182x202 71 5/8 x 79 4/8	L 214 H 95 P 232 W 84 2/8 H 37 3/8 D 91 3/8